

JLE

Guided compact cylinders

The JLE series guided compact cylinders are studied for applications requiring reduced dimensions and in case anti-rotation has to be guaranteed.

Bores: 12 - 16 - 20 - 25 - 32 - 40 - 50 - 63

Strokes: until 200 mm

Versions: guide on bearings (JLES) ideal for high side loads, guide on ball bushing (JLEV) suitable for high precision applications and uniform speed

Fixing: 3 fixing type (top, bottom and rear fixing)

Connections: on two sides



TECHNICAL CHARACTERISTICS

Ambient temperature	-20 ÷ +80 °C
Fluid	compressed air with or without lubrication
Max. pressure	10 bar
Bores	Ø 012 - 016 - 020 - 025 - 032 - 040 - 050 - 063
Cushionings	standard supplied

CONSTRUCTIVE CHARACTERISTICS

Body	aluminium alloy
Shafts	C40 chromium-plated steel (JLES) C40 hardened steel (JLEV)
Piston	aluminium alloy
Piston rod	C40 chromium-plated steel
Guide bearings	bronze (JLES) ball bushing (JLEV)
Piston seals	polyurethane
Flange	steel
Cushioning seals	polyurethane
Magnet	standard supplied

CODIFICATION KEY

J	L	E	S	0	1	2	0	0	3	0
1		2		3			4			

1 Series	2 Slide bearings	3 Bore (mm)	4 Standard strokes (mm)
JLE = Guided compact cylinders	S = Bearings V = Ball bushing	012 = Ø12 032 = Ø32 016 = Ø16 040 = Ø40 020 = Ø20 050 = Ø50 025 = Ø25 063 = Ø63	0010 = 10 0040 = 40 0125 = 125 0020 = 20 0050 = 50 0150 = 150 0025 = 25 0075 = 75 0175 = 175 0030 = 30 0100 = 100 0200 = 200

Fixing schemes

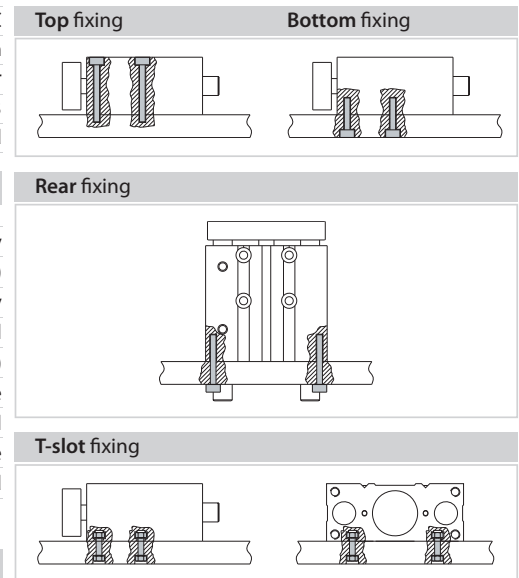

Ø	Standard strokes (mm)											
	10	20	25	30	40	50	75	100	125	150	175	200
12	[Shaded bar]											
16	[Shaded bar]											
20	[Shaded bar]											
25	[Shaded bar]											
32	[Shaded bar]											
40	[Shaded bar]											
50	[Shaded bar]											
63	[Shaded bar]											

Special versions upon request:

- metal rods scrapers
- pneumatic cushioning
- high temperature (+120°)

* Extra strokes upon request

Theoretical forces (N) at working pressure (bar)

Cylinder Ø	Working surface area (mm ²)		Working pressure (bar)									
	Thrust	Traction	Thrust					Traction				
			2	4	6	8	10	2	4	6	8	10
12	113	85	23	45	68	90	113	17	34	51	68	85
16	201	173	40	80	121	161	201	35	69	104	138	173
20	314	264	63	126	189	251	314	53	106	158	211	264
25	491	412	98	196	294	393	491	82	165	247	330	412
32	804	691	161	322	482	643	804	138	276	415	553	691
40	1257	1056	251	503	754	1006	1257	211	422	634	845	1056
50	1963	1649	393	785	1178	1570	1963	330	660	989	1319	1649
63	3117	2803	623	1247	1870	2494	3117	561	1121	1682	2242	2803

Cylinder mass

JLES/JLEV

Cylinder Ø	Strokes (mm)											
	10	20	25	30	40	50	75	100	125	150	175	200
	g											
12	220	250	-	290	330	360	460	550	-	-	-	-
16	352	402	-	452	502	552	752	902	-	-	-	-
20	-	689	-	830	910	990	1310	1510	1625	1740	1855	1970
25	-	870	-	990	1080	1260	1680	2100	2500	2900	3300	3700
32	-	-	1770	-	-	2120	2770	3080	3408	3737	4066	4395
40	-	-	1990	-	-	2390	2940	3050	3460	3880	4300	4720
50	-	-	3355	-	-	3955	4755	5355	5955	6555	7155	7755
63	-	-	4030	-	-	5070	5786	6505	7224	7943	8662	9380

OPERATING CONDITIONS

Allowable lateral load (N)

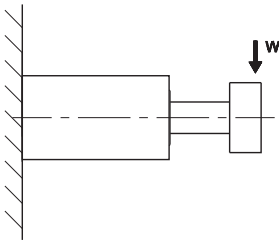

Guide with bearings - JLES

Ø	Strokes (mm)											
	10	20	25	30	40	50	75	100	125	150	175	200
12	28	25	-	23	20	18	33	25	-	-	-	-
16	67	61	-	57	50	43	58	51	-	-	-	-
20	-	74	-	67	63	59	91	83	75	69	61	57
25	-	125	-	116	110	102	125	114	102	93	86	80
32	-	-	198	-	-	170	190	171	156	140	127	115
40	-	-	198	-	-	170	190	171	156	140	127	115
50	-	-	292	-	-	269	305	280	253	229	198	177
63	-	-	292	-	-	269	305	280	253	229	198	177

Guide with ball bushings - JLEV

Ø	Strokes (mm)											
	10	20	25	30	40	50	75	100	125	150	175	200
12	28	23	-	20	33	29	24	20	-	-	-	-
16	49	43	-	39	85	77	68	60	-	-	-	-
20	-	82	-	74	110	101	91	79	64	55	46	41
25	-	118	-	105	125	114	98	90	83	75	67	59
32	-	-	158	-	-	141	194	163	146	122	107	93
40	-	-	158	-	-	141	194	163	146	122	107	93
50	-	-	225	-	-	187	223	207	184	162	143	125
63	-	-	225	-	-	187	223	207	184	162	143	125

It shows the dynamic allowable value when the cylinder is working with lateral load W at the top of the guide rods (vertical load against the guide rods).

1

Allowable moment (Nm)

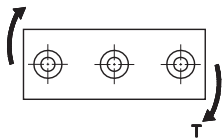

Guide with bearings- JLES

Ø	Strokes (mm)											
	10	20	25	30	40	50	75	100	125	150	175	200
12	0,60	0,50	-	0,45	0,65	0,60	0,47	0,41	-	-	-	-
16	1,45	1,32	-	1,17	1,68	1,55	1,29	1,15	-	-	-	-
20	-	1,84	-	1,69	1,50	1,32	2,90	2,75	2,6	2,3	2,1	1,9
25	-	3,90	-	3,75	3,65	3,50	4,20	4,00	3,80	3,30	2,85	2,50
32	-	-	6,80	-	-	6,50	7,40	7,00	6,60	5,60	4,80	4,20
40	-	-	7,50	-	-	6,90	9,10	8,30	7,90	7,00	4,90	5,90
50	-	-	14,30	-	-	12,50	13,10	12,85	11,20	10,80	10,00	8,9
63	-	-	15,90	-	-	13,30	14,50	13,10	14,10	13,50	12,30	10,70

Guide with ball bushings - JLEV

Ø	Strokes (mm)											
	10	20	25	30	40	50	75	100	125	150	175	200
12	0,88	0,72	-	0,61	0,81	0,72	0,57	0,49	-	-	-	-
16	2,20	1,80	-	1,52	2,90	2,63	2,05	1,78	-	-	-	-
20	-	2,00	-	1,85	3,20	2,90	2,5	2,3	1,90	1,60	1,30	1,20
25	-	3,60	-	2,90	5,80	5,00	4,50	3,90	3,00	2,70	2,50	2,00
32	-	-	8,80	-	-	6,80	7,70	6,80	6,00	5,20	4,40	3,90
40	-	-	9,70	-	-	8,60	8,00	7,50	6,30	5,50	4,90	4,00
50	-	-	12,00	-	-	13,80	14,90	13,90	12,10	11,50	10,20	9,90
63	-	-	11,30	-	-	16,50	15,50	14,30	13,80	12,00	11,60	10,10

It shows the dynamic allowable value when the cylinder is working with a rotating torque T at the top of the guide rods.

JLES/JLEV Ø 12 ÷ 63 mm

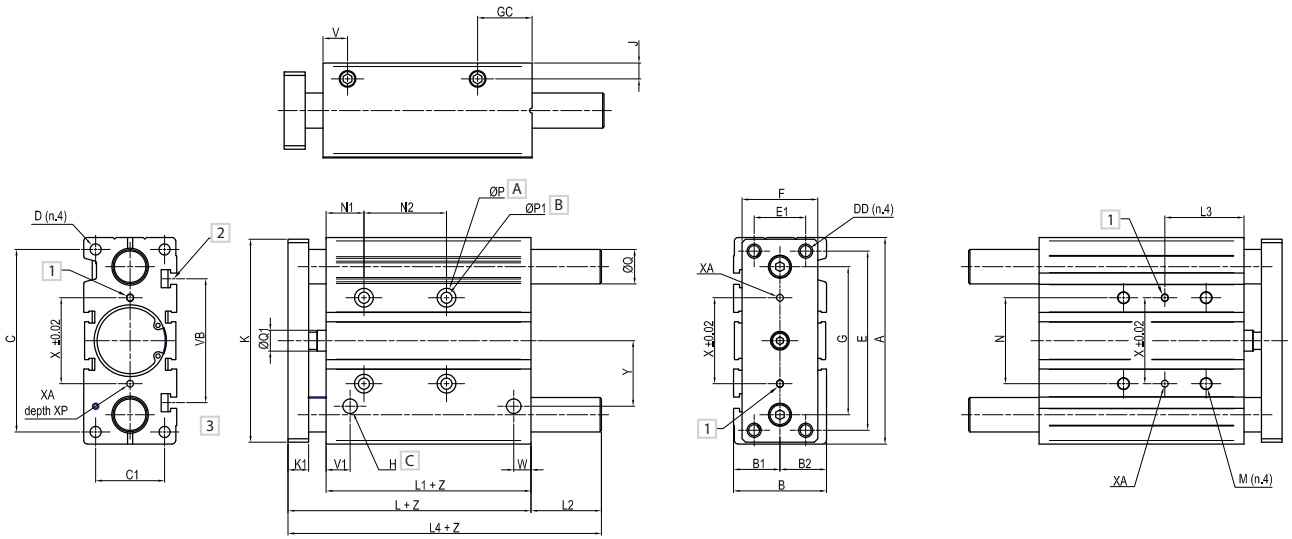

1 Detail

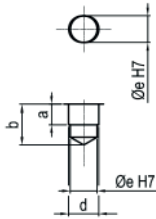

Ø	a	b	d	e
12	3	6	3,5	3
16	3	6	3,5	3
20	3	6	3,5	3
25	3	6	4,5	4
32	3	6	4,5	4
40	3	8	4,5	4
50	4	8	6	5
63	4	8	6	5

2 Detail (T-slot)

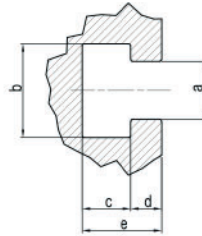

Ø	a	b	c	d	e
12	4,4	7,4	3,7	2,5	6,2
16	4,4	7,4	3,7	2,5	6,2
20	5,5	8,4	4,5	2,8	7,3
25	5,5	8,4	4,5	3	7,5
32	6,5	10,5	5,5	3,5	9
40	6,5	10,5	5,5	4	9
50	8,5	13,5	7,5	4,5	12
63	11	17,8	10	7	16,5

3 Detail (sensor groove)

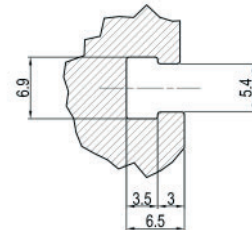

- A N.4 Spot-facings
- B N.4 Through holes
- C N.4 Supply ports

Z = Stroke

Ø	A	B	B1	B2	C	C1	D	DD	E	E1	F	G	GC	J	H	K	K1
12	58	26	13	13	50	18	M4 x 10	M4	48	14	22	41	18	5	M5	56	7
16	64	30	15	15	56	22	M5 x 12	M5	54	16	25	46	18	5	M5	62	8
20	83	36	17	19	72	24	M5 x 13	M5	70	18	30	54	24,5	6,5	G1/8	81	10
25	93	42	21	21	82	30	M6 x 15	M6	78	26	38	64	25	7,5	G1/8	91	10
32	112	48	26	25	98	34	M8 x 20	M8	96	30	44	78	30,5	9	G1/8	110	12
40	120	54	27	27	106	40	M8 x 20	M8	104	30	44	86	31	9	G1/8	118	44
50	148	64	32	32	130	46	M10 x 22	M10	130	40	60	110	35	9,5	G1/4	146	44
63	162	78	39	39	142	58	M10 x 22	M10	130	50	70	124	35	11	G1/4	158	49

Ø	L	L1	M	N	N1	P	P1	Q1	S	V	V1	VB	W	X	X1	XA	XP	Y	Q (JLES)	Q (JLEV)
12	42	29	M4 x 10	23	5	8 x 4,5	4,3	6	5	10	-	-	7	23	8,5	3	6	18	8	6
16	46	33	M5 x 10	24	5	8 x 4,5	4,3	8	3	11	-	-	8	24	10	3	6	19	10	8
20	53	37	M6 x 12	28	17	9,5 x 5,5	5,6	10	6	10,5	-	-	8,5	28	11,5	3	6	25	12	10
25	53,5	37,5	M6 x 12	34	17	9,5 x 5,5	5,6	10	6	11,5	-	-	9	34	13,5	4	6	28,5	16	13
32	59,5	37,5	M8 x 16	42	21	11 x 7,5	6,6	12	10	12,5	-	-	9	42	16	4	6	34	20	16
40	66	44	M8 x 16	50	22	11 x 7,5	6,6	12	12	14	14	72	10	50	18	4	6	38	20	20
50	72	44	M8 x 20	66	24	14 x 9	8,6	16	12	12	12	92	11	66	21,5	5	8	47	25	25
63	77	49	M8 x 20	80	24	14 x 9	8,6	16	12	16,5	16,5	110	13,5	80	28	5	8	55	25	25

Ø	JLES			
	L4		L2	
	Z=10÷50	Z=75÷100	Z=10÷50	Z=75÷100
12	42	60,5	0	18,5
	Z=10÷50	Z=75÷100	Z=10÷50	Z=75÷100
16	46	64,5	0	18,5
	Z=20÷50	Z=75÷200	Z=20÷50	Z=75÷200
20	53	84,5	0	31,5
	Z=20÷50	Z=75÷200	Z=20÷50	Z=75÷200
25	53,5	85	0	31,5
	Z=25÷50	Z=75÷200	Z=25÷50	Z=75÷200
32	97	107	37,5	47,5
	Z=25÷50	Z=75÷200	Z=25÷50	Z=75÷200
40	97	107	31	41
	Z=25÷50	Z=75÷200	Z=25÷50	Z=75÷200
50	106,5	118	34,5	46
	Z=25÷50	Z=75÷200	Z=25÷50	Z=75÷200
63	106,5	118	29,5	41

Ø	JLEV					
	L4		L2			
	Z=10÷30	Z=40÷100	Z=10÷30	Z=40÷100		
12	43	55	1	13		
	Z=10÷30	Z=40÷100	Z=10÷30	Z=40÷100		
16	46	66	0	20		
	Z=20÷30	Z=40÷200	Z=20÷30	Z=40÷200		
20	53	85,5	0	32,5		
	Z=20÷30	Z=40÷200	Z=20÷30	Z=40÷200		
25	53,5	86	0	32,5		
	Z=25÷50	Z=75÷200	Z=25÷50	Z=75÷200		
32	97	107	37,5	47,5		
	Z=25÷50	Z=75÷200	Z=25÷50	Z=75÷200		
40	97	107	31	41		
	Z=25	Z=50	Z=75÷200	Z=25	Z=50	Z=75÷200
50	106,5	114	118	34,5	42	46
	Z=25	Z=50	Z=75÷200	Z=25	Z=50	Z=75÷200
63	106,5	114	118	29,5	37	41

Ø	JLES/JLEV					
	N2			L3		
	Z=10÷30	Z=40÷100	-	Z=10÷30	Z=40÷100	-
12	20	40	-	15	25	-
	Z=10÷30	Z=40÷100	-	Z=10÷30	Z=40÷100	-
16	24	44	-	17	27	-
	Z=20÷30	Z=40÷100	Z=125÷200	Z=20÷30	Z=40÷100	Z=125÷200
20	24	44	120	29	39	77
	Z=20÷30	Z=40÷100	Z=125÷200	Z=20÷30	Z=40÷100	Z=125÷200
25	24	44	120	29	39	77
	Z=25	Z=50÷100	Z=125÷200	Z=25	Z=50÷100	Z=125÷200
32	24	48	124	33	45	83
	Z=25	Z=50÷100	Z=125÷200	Z=25	Z=50÷100	Z=125÷200
40	24	48	124	34	46	84
	Z=25	Z=50÷100	Z=125÷200	Z=25	Z=50÷100	Z=125÷200
50	24	48	124	36	48	86
	Z=25	Z=50÷100	Z=125÷200	Z=25	Z=50÷100	Z=125÷200
63	28	52	128	38	50	88