

ORIGINAL

UNIVER Original design and technology

INDUSTRIALIZED

Industrialized components and advanced technology

REDUCED DIMENSIONS

60% less than standard cylinders

NON-ROTATING

Non-rotation octagonal tube standard supplied

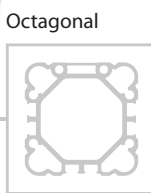
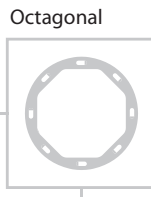
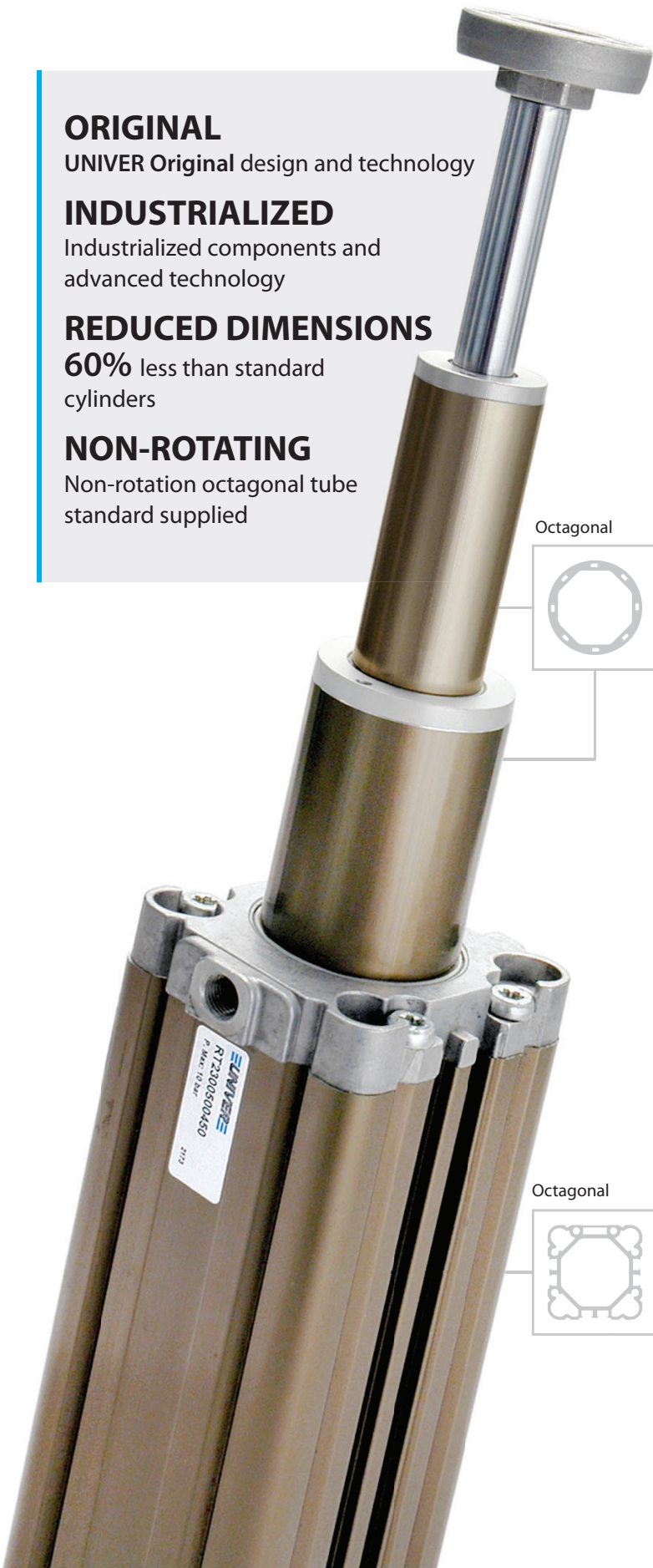

RT2

2 stages Ø 25 ÷ 63 mm



RT3

3 stages Ø 40 ÷ 63 mm

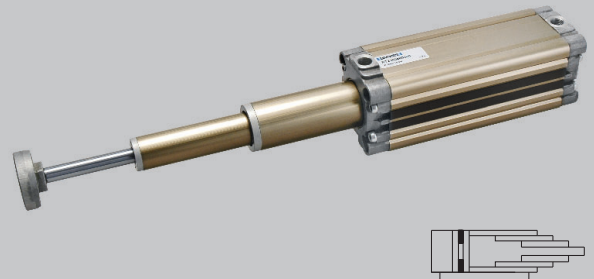

Comparison of overall dimensions stroke 300 mm (A)

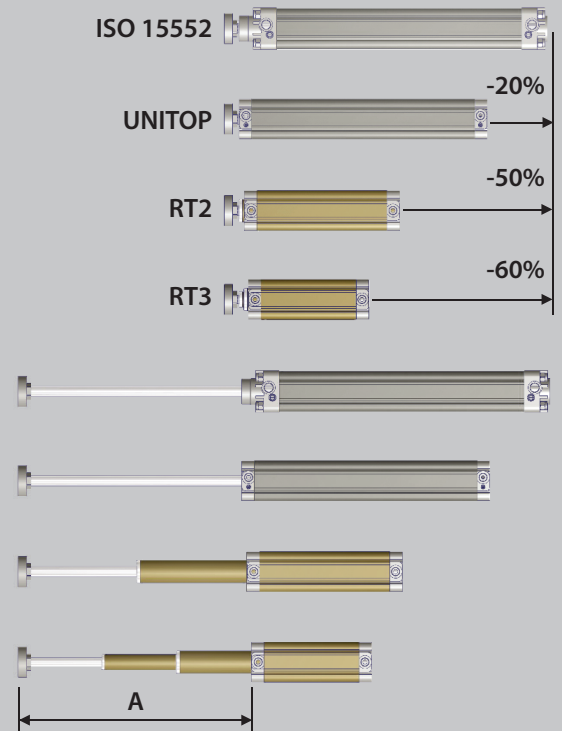

CHARACTERISTICS

Ambient temperature	-20 ÷ +80 °C
Fluid	filtered air, with or without lubrication
Working pressure	1,5 ÷ 10 bar
End-caps	die-cast aluminium
Barrel	internally/externally anodized aluminium
Piston	aluminium
Guide slide	acetalic resin
Piston rod	non-rotating, chromium-plated steel, with flange (female piston rod) stainless steel upon request
Piston seals	NBR
Guide bush for piston rod	acetalic resin
Shock absorber seals	NBR
Magnet	standard supplied (stage 1)

Telescopic cylinders work under optimal conditions when the load is in axial position, i.e. when the cylinder is placed vertically, working either upward or downward. They can obviously work also horizontally and cantilevered, but in this case it is needed to:

- Reduce the maximum stroke by 50% compared to nominal maximum strokes
- Request cylinders with slide units
- Support the radial load by means of other devices such as carriages, slides or sliding guides

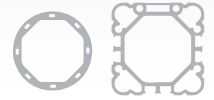
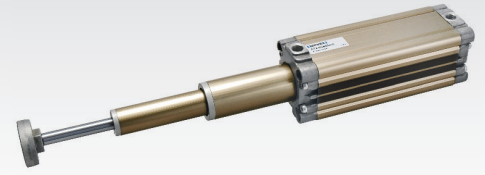

Available ATEX version upon request
CE Ex II 2Gc IICT5 II 2Dc T100°C

CODIFICATION KEY

R	T	2	2	0	0	3	2	0	6	0	0		
1	2	3	4	5			6			7	8		

1 Series	2 Rod	3 Stages	4 Type
RT = Ø 25÷63 mm - 2/3 Stage Telescopic Pneumatic Cylinders (with non-rotating piston rod and elastic shock absorber seals)	1 = Stainless steel piston rod 2 = Chromium-plated steel piston rod	2 = 2 stages 3 = 3 stages	0 = D.A. Female piston rod 3 = D.A. Male piston rod

D.A. = Double acting

5 Bore (mm)	6 Stroke (mm)	7 Option	8 ATEX Option
2 stages 025 = Ø25 040 = Ø40 032 = Ø32 050 = Ø50 040 = Ø40 063 = Ø63 050 = Ø50 063 = Ø63	2 stages 0100 - 0120 - 0160 - 0180 - 0200 - 0300 - 0400 - 0500 0600 - 0700 - 0800 - 0900 - 1000 - 1100 - 1200 Max stroke: 0300 (Ø25) 0900 (Ø50) 0400 (Ø32) 1200 (Ø63) 0600 (Ø40)	I = Without flange (only for female piston rod) L = Freely rotating piston rod (without flange) M = With telescopic magnetic shaft (stage 2-3) except for Ø 25, only for female piston rod	X = Atex (upon request) See ATEX Catalogue for types and versions
	3 stages 0150 - 0180 - 0210 - 0240 - 0270 - 0300 - 0360 - 0450 0600 - 0750 - 900 - 1050 - 1200 - 1500 - 1800 Max stroke: 1200 (Ø40) 1500 (Ø50) 1800 (Ø63)		

Nominal tolerance on stroke (mm) and maximum applicable torque (Nm) for non-rotating piston rod

Theoretical forces at 6 bar (N) (2 stages)

Theoretical forces at 6 bar (N) (3 stages)

Ø	Tolerances		Applicable torque	
	mm		Nm	
	2 stages	3 stages	2 stages	3 stages
25	+2/0	-	0,5	-
32	+3,2/0	-	0,8	-
40	+3,2/0	+4/0	1	0,5
50	+3,2/0	+4/0	2	0,8
63	+3,2/0	+4/0	3	1

Ø	Available surface		Working pressure	
	mm ²		bar	
	thrust	traction	thrust	traction
25	201	111	123	65
32	314	201	192	123
40	490	377	300	231
50	804	603	492	369
63	1256	1055	769	649

Ø	Available surface		Working pressure	
	mm ²		bar	
	thrust	traction	thrust	traction
40	201	111	123	65
50	314	201	192	123
63	490	377	300	231

FIXING ELEMENTS AND ACCESSORIES

Ø	Female hinge with pin	Counter hinge 90°	Male articulated hinge	Rear male hinge	Front / rear flange	Angle bracket	DF sensor and DHF covering strip	Cable clamping for DF sensor
25								
32	-	-	-	RPF-11025	RTF-12025	RTF-13025	DF DHF-0020100	DF-001
40	KF-10032A	KF-19032	KF-11032S	KF-11032	KF-12032	KF-13032		
50	KF-10040A	KF-19040	KF-11040S	KF-11040	KF-12040	KF-13040		
63	KF-10050A	KF-19050	KF-11050S	KF-11050	RTF-12050	RTF-13050		
63	KF-10063A	KF-19063	KF-11063S	KF-11063	RTF-12063	RTF-13063		