

UAGP

Unità rotante pneumatica UNICLAMP

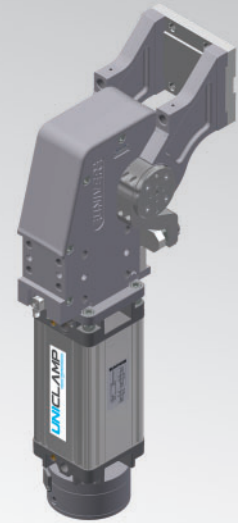

U	A	G	P	0	8	0	O	A	0	9	0	B	S	0
1	2	3	4	5	6	7	8	9						

1 Serie	2 Versione	3 Taglia
UAG = Unità rotante con angoli di rotazione determinati UNICLAMP	P = Pneumatica	075 = 75Nm Ø80 mm 215 = 210Nm Ø125 mm 080 = 60Nm Ø80 mm 300 = 300Nm Ø160 mm 120 = 110Nm Ø100 mm 350 = 350Nm Ø160 mm 150 = 120Nm Ø100 mm 355 = 350Nm Ø160 mm 155 = 120Nm Ø100 mm 600 = 600Nm Ø200 mm 170 = 170Nm Ø125 mm 605 = 600Nm Ø200 mm 210 = 210Nm Ø125 mm
4 Posizione tavola	5 Sensore	6 Angoli di rotazione
V = Verticale 180° O = Orizzontale 90° Z = Verticale, speculare alla posizione V P = Orizzontale, speculare alla posizione O (massima apertura angolare 60°)	K = Sensore elettronico PNP (ottico) (DF-K) A = Sensore elettronico PNP (ottico) per angolo di apertura (DF-K) + sensore freno DF-U)	120 = 120° 090 = 90° 060 = 60° 045 = 45°
7 Blocco di stazionamento	8 Connessioni	9 Revisione prodotto
B = Con blocco di stazionamento W = Senza blocco di stazionamento M = Funzione di sblocco manuale su freno di stazionamento	S = Lato sinistro D = Lato destro F = Lato frontale P = Lato posteriore	Assegnato da UNIVER

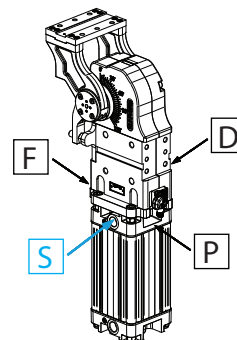

UNIVER SpA raccomanda di far convalidare all'ufficio tecnico UNIVER tutte le applicazioni di Unità Rotanti

UAGP120OK__WS0

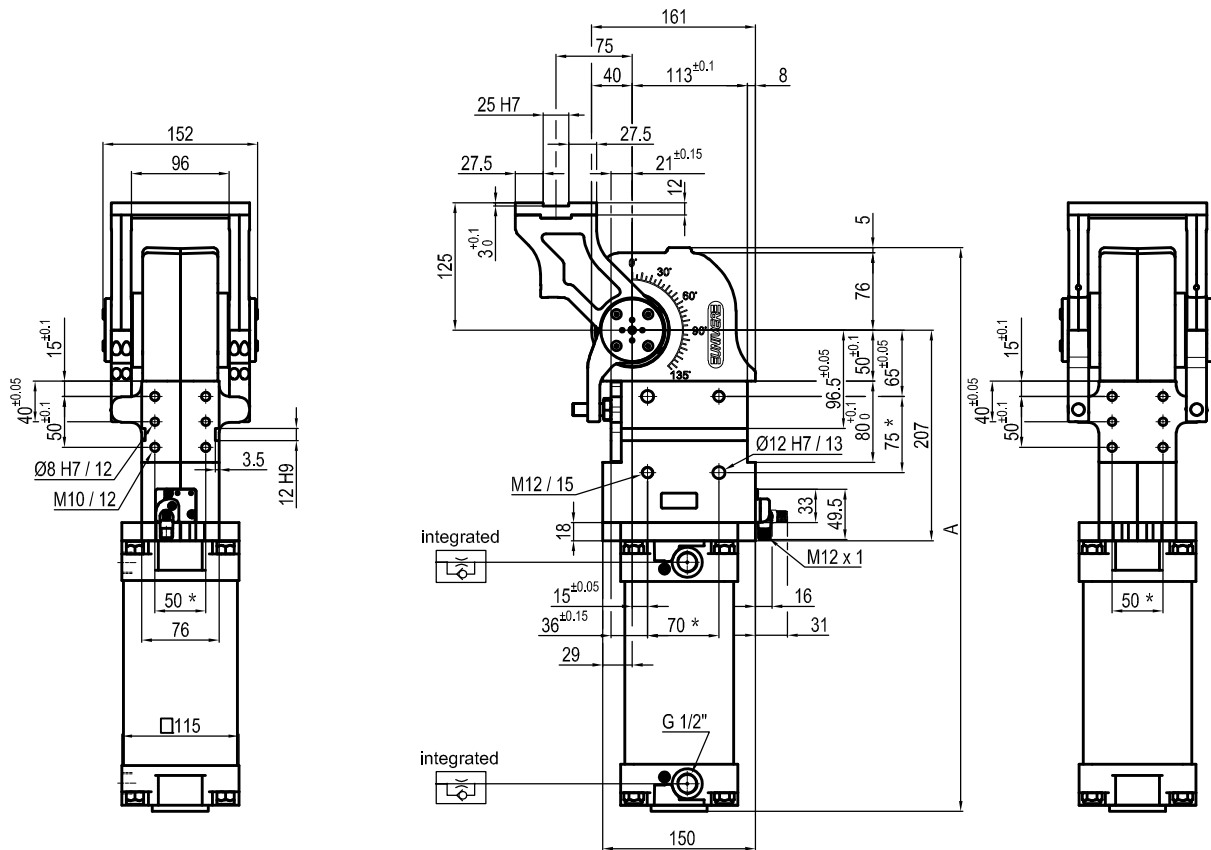

Pivot rotation in degrees	A
45°	492
60°	503.5
90°	528.5
120°	553.5

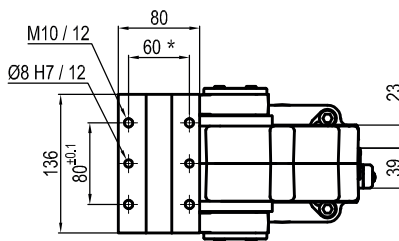

Passive brake

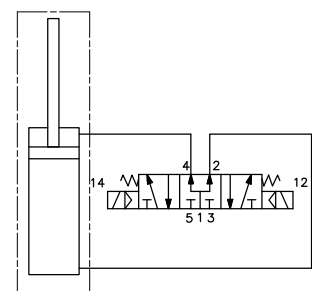

Size	Holding moment	Max. torque at the rotary table 0,55 MPa	Weight
120	4000 Nm	110 Nm	16,7 Kg

Min./Max. operating pressure: **0,4 / 0,6 MPa**
 Operating temperature: **5° ÷ 45° C**
 Predetermine pivot rotation in degrees: **45°- 60°- 90°- 120°**
 Rotary table position: **Horizontal 90°**
 Electronic sensor with M12 swivel connector, from 0° or 90°, in steps of 10°
 Supply voltage: 10 ÷ 30 Vdc
 IP code: **IP 65**

*: TOLERANCE BETWEEN DOWEL HOLES ± 0,02, BETWEEN SCREW HOLES ± 0,1

Subject to technical modifications without notice

UAGP120PK__WSO

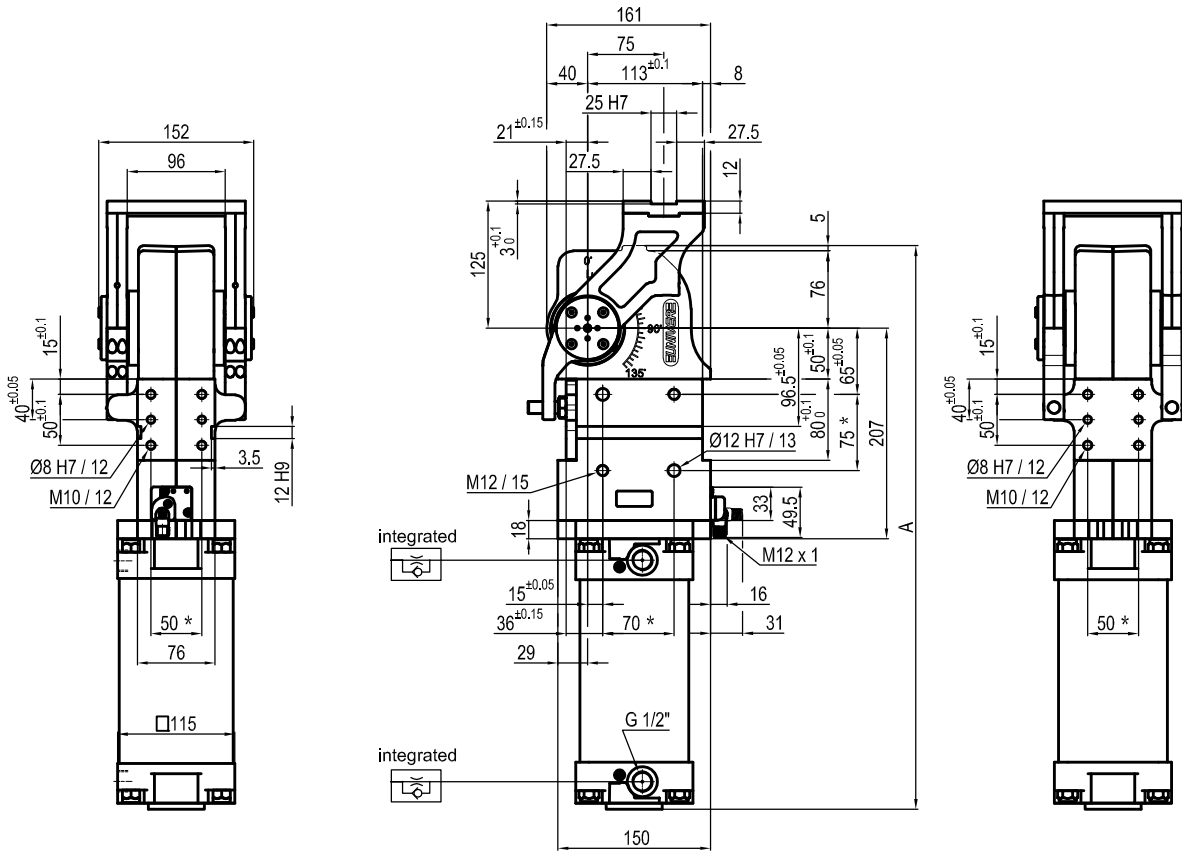

Pivot rotation in degrees	A
45°	492
60°	503.5

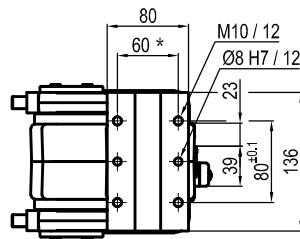

Passive brake

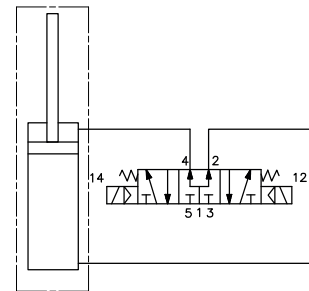

Size	Holding moment	Max. torque at the rotary table 0,55 MPa	Weight
120	4000 Nm	110 Nm	16,7 Kg

Min./Max. operating pressure: **0,4 / 0,6 MPa**
 Operating temperature: **5° ÷ 45° C**
 Predetermine pivot rotation in degrees: **45°- 60°**
 Rotary table position: **Horizontal mirror of O**
 Electronic sensor with M12 swivel connector, from 0° or 90°, in steps of 10°
 Supply voltage: 10 ÷ 30 Vdc
 IP code: **IP 65**

*: TOLERANCE BETWEEN DOWEL HOLES ± 0,02, BETWEEN SCREW HOLES ± 0,1

Subject to technical modifications without notice

UAGP120VK___WSO

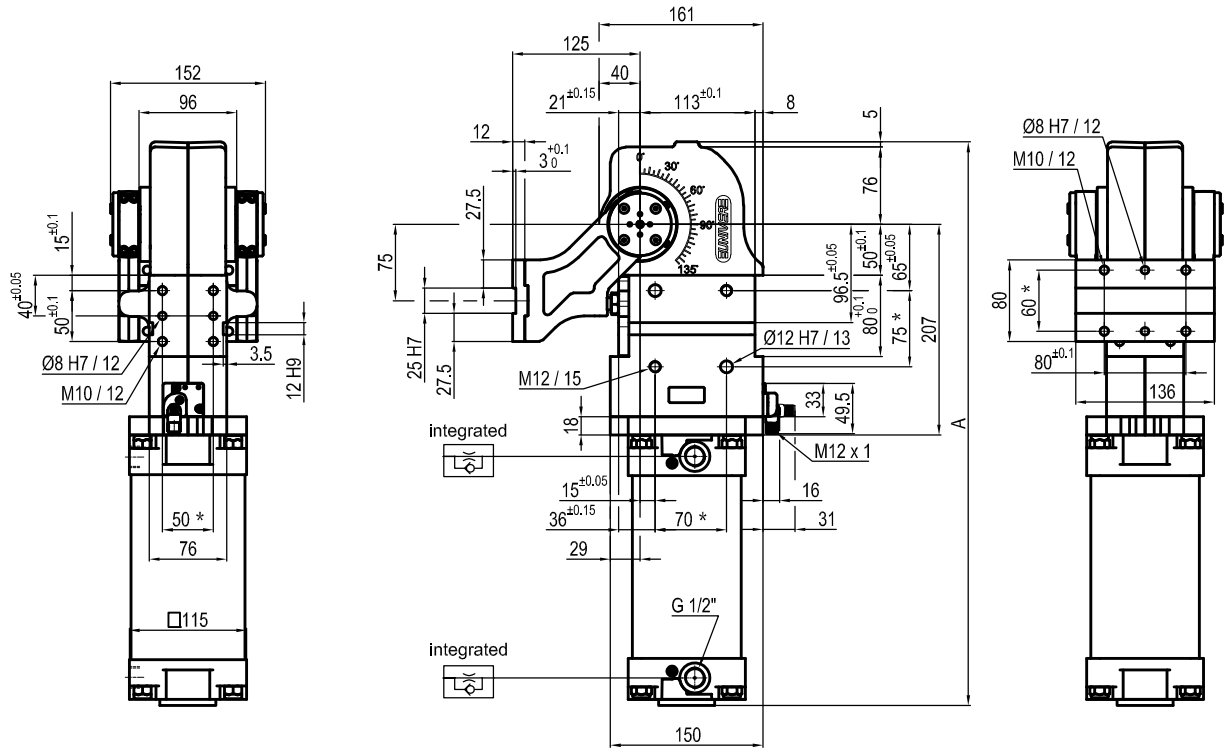

Pivot rotation in degrees	A
45°	492
60°	503.5
90°	528.5
120°	553.5

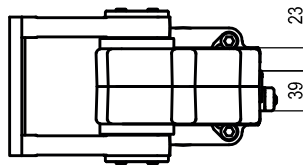

Passive brake

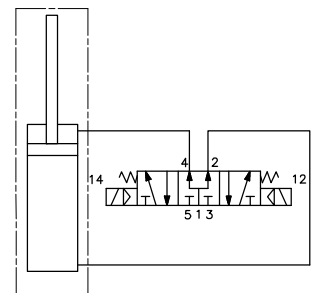

Size	Holding moment	Max. torque at the rotary table 0,55 MPa	Weight
120	4000 Nm	110 Nm	16,7 Kg

Min./Max. operating pressure: **0,4 / 0,6 MPa**
 Operating temperature: **5° ÷ 45° C**
 Predetermine pivot rotation in degrees: **45°- 60°- 90°- 120°**
 Rotary table position: **Vertical 180°**
 Electronic sensor with M12 swivel connector, from 0° or 90°, in steps of 10°
 Supply voltage: 10 ÷ 30 Vdc
 IP code: **IP 65**

*: TOLERANCE BETWEEN DOWEL HOLES ± 0,02, BETWEEN SCREW HOLES ± 0,1

Subject to technical modifications without notice

UAGP120ZK__WSO

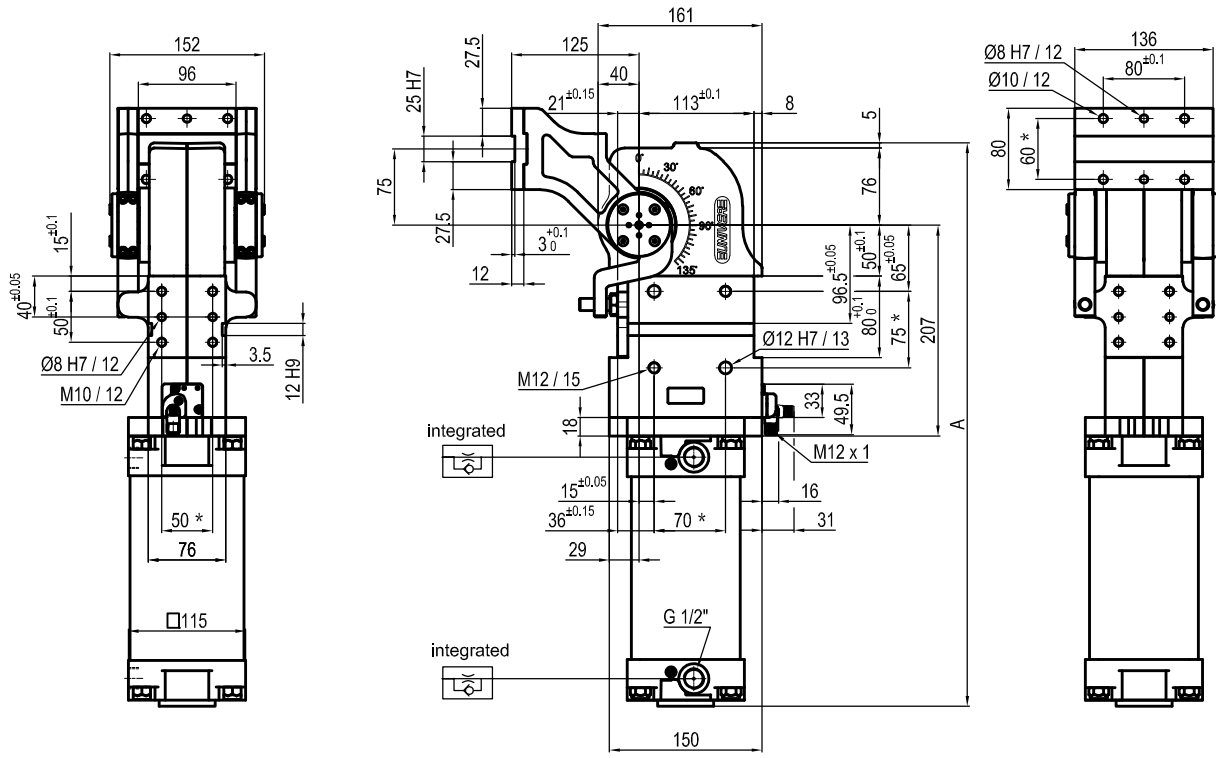

Pivot rotation in degrees	A
45°	492
60°	503.5
90°	528.5
120°	553.5

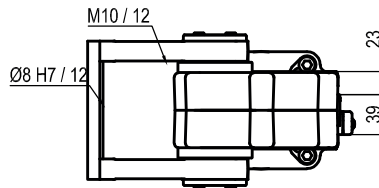

Passive brake

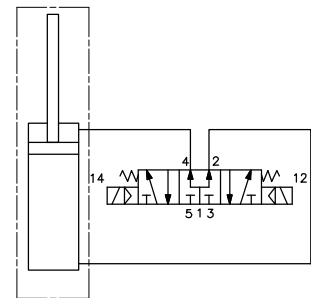

Size	Holding moment	Max. torque at the rotary table 0,55 MPa	Weight
120	4000 Nm	110 Nm	16,7 Kg

 Min./Max. operating pressure: **0,4 / 0,6 MPa**

 Operating temperature: **5° ÷ 45° C**

 Predetermine pivot rotation in degrees: **45°- 60°- 90°- 120°**

 Rotary table position: **Vertical mirror of V**

Electronic sensor with M12 swivel connector, from 0° or 90°, in steps of 10°

Supply voltage: 10 ÷ 30 Vdc

 IP code: **IP 65**

*: TOLERANCE BETWEEN DOWEL HOLES ± 0.02, BETWEEN SCREW HOLES ± 0.1

Subject to technical modifications without notice