

UAGP

UNICLAMP Pneumatic power pivot

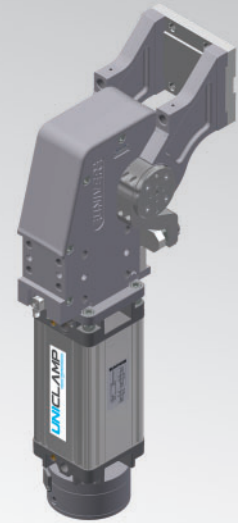

U	A	G	P	0	8	0	O	A	0	9	0	B	S	0
1	2	3	4	5	6	7	8	9						

1 Series	2 Version	3 Size
UAG = UNICLAMP Power pivot with fixed opening angle	P = Pneumatic	075 = 75Nm Ø80 mm 215 = 210Nm Ø125 mm 080 = 60Nm Ø80 mm 300 = 300Nm Ø160 mm 120 = 110Nm Ø100 mm 350 = 350Nm Ø160 mm 150 = 120Nm Ø100 mm 355 = 350Nm Ø160 mm 155 = 120Nm Ø100 mm 600 = 600Nm Ø200 mm 170 = 170Nm Ø125 mm 605 = 600Nm Ø200 mm 210 = 210Nm Ø125 mm
4 Table position	5 Sensor	6 Pivot rotation angles
V = Vertical 180° O = Horizontal 90° Z = Vertical, mirror of V position P = Horizontal, mirror of O position (Max opening angle 60°)	K = Electronic sensor PNP (optical) (DF-K) A = PNP Electronic Sensor (optic) for opening angle (DF-K) + brake sensor (DF-U)	120 = 120° 090 = 90° 060 = 60° 045 = 45°
7 Brake system	8 Connections	9 Product revision
B = With brake W = Without brake M = With brake and manual unlock	S = Left side D = Right side F = Front side P = Rear side	Assigned by UNIVER

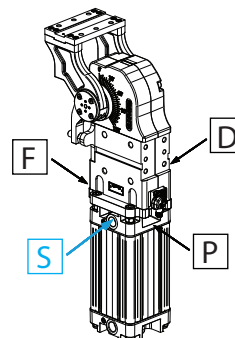

UNIVER S.p.A recommends that all power pivot applications are validated by UNIVER technical department

UAGP605OK__WS0

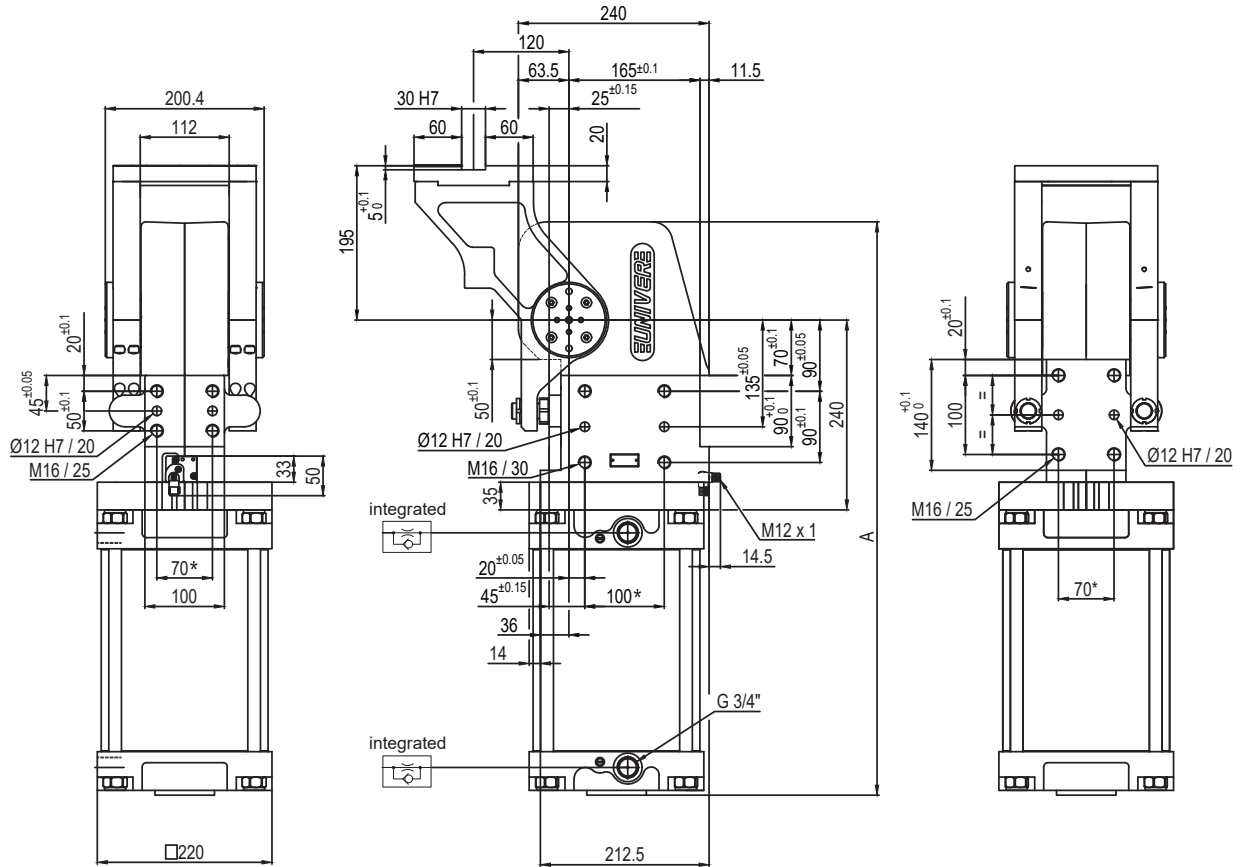

Pivot rotation in degrees	A
45°	632.5
60°	648.5
90°	685.5
120°	724.5

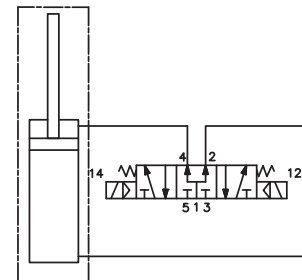
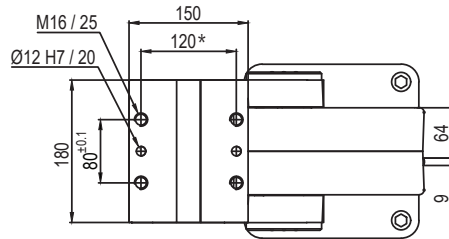

Size	Holding moment	Max. torque at the rotary table 0,55 MPa	Weight
605	8000 Nm	600 Nm	54 Kg

Min./Max. operating pressure: **0,4 / 0,6 MPa**
 Operating temperature: **5° ÷ 45° C**
 Predetermine pivot rotation in degrees: **45°- 60°- 90°- 120°**
 Rotary table position: **Horizontal 90°**
 Electronic sensor with M12 swivel connector, from 0° or 90°, in steps of 10°
 Supply voltage: 10 ÷ 30 Vdc
 IP code: **IP 65**

*: TOLERANCE BETWEEN DOWEL HOLES ± 0,02, BETWEEN SCREW HOLES ± 0,1

Subject to technical modifications without notice

UAGP605PK__WSO

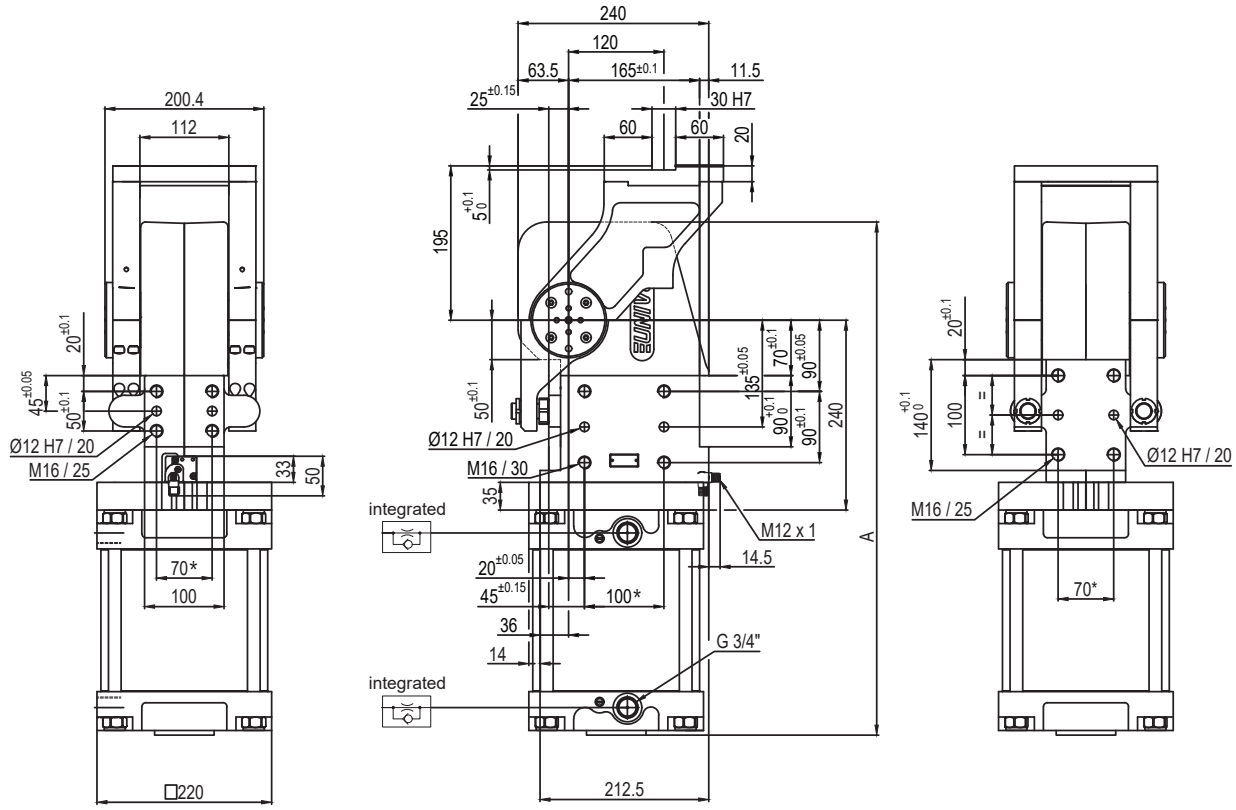

Pivot rotation in degrees	A
45°	632.5
60°	648.5

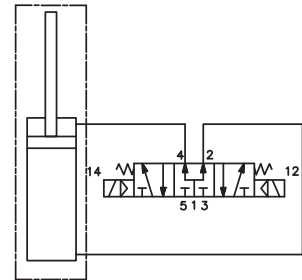
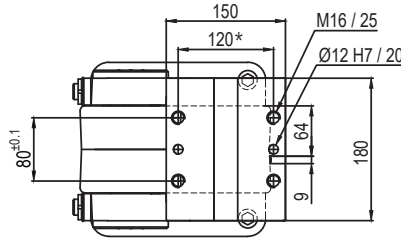

Size	Holding moment	Max. torque at the rotary table 0,55 MPa	Weight
605	8000 Nm	600 Nm	54 Kg

Min./Max. operating pressure: **0,4 / 0,6 MPa**
 Operating temperature: **5° ÷ 45° C**
 Predetermine pivot rotation in degrees: **45°- 60°**
 Rotary table position: **Horizontal mirror of O**
 Electronic sensor with M12 swivel connector, from 0° or 90°, in steps of 10°
 Supply voltage: 10 ÷ 30 Vdc
 IP code: **IP 65**

*: TOLERANCE BETWEEN DOWEL HOLES ± 0,02, BETWEEN SCREW HOLES ± 0,1

Subject to technical modifications without notice

UAGP605VK__WSO

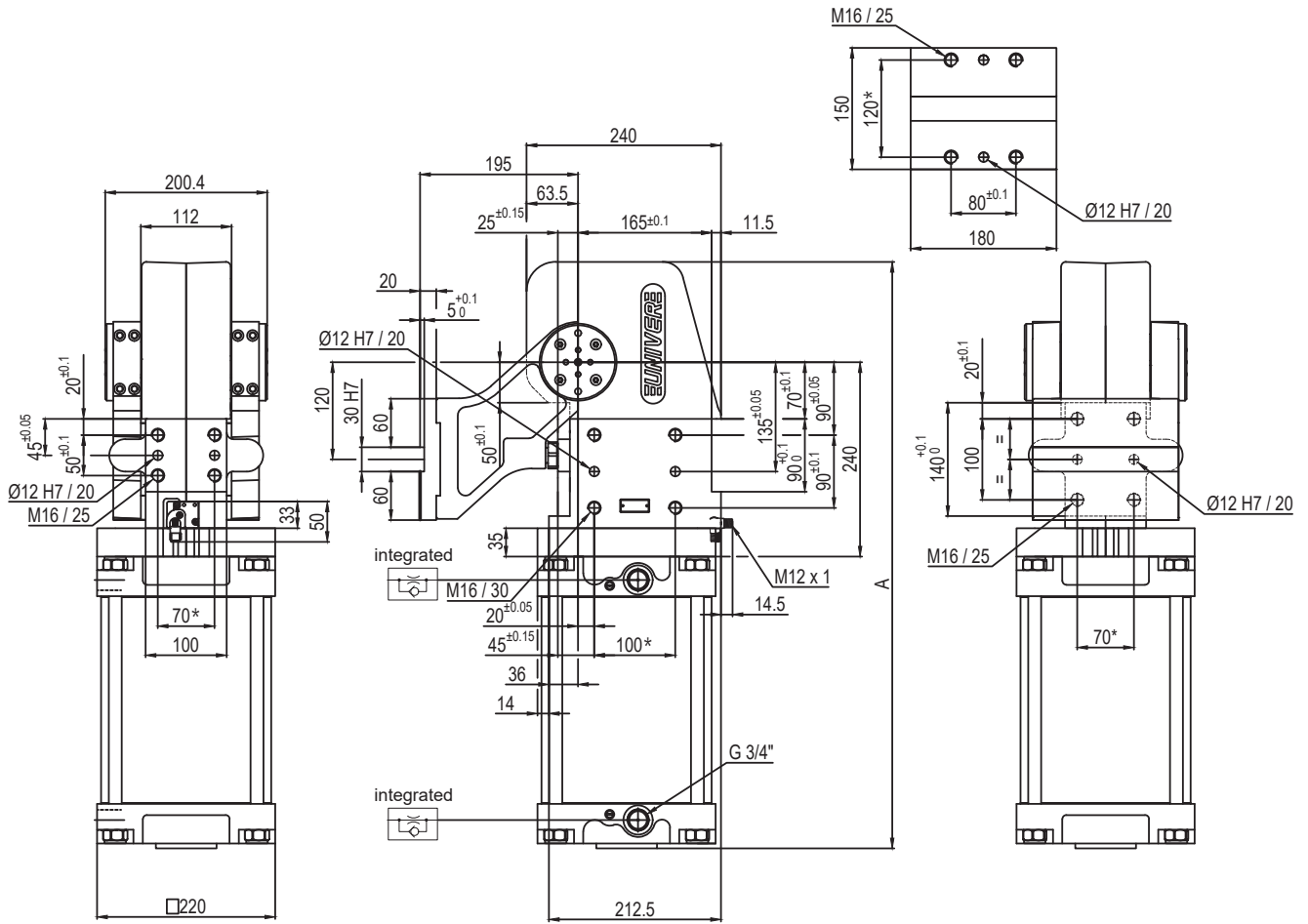

Pivot rotation in degrees	A
45°	632.5
60°	648.5
90°	685.5
120°	724.5

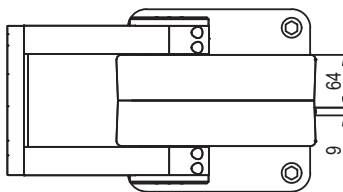

Passive brake

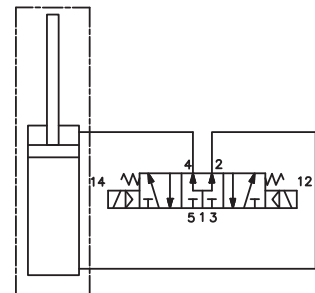

Size	Holding moment	Max. torque at the rotary table 0,55 MPa	Weight
605	8000 Nm	600 Nm	54 Kg

Min./Max. operating pressure: **0,4 / 0,6 MPa**
 Operating temperature: **5° ÷ 45° C**
 Predetermine pivot rotation in degrees: **45° - 60° - 90° - 120°**
 Rotary table position: **Vertical 180°**
 Electronic sensor with M12 swivel connector, from 0° or 90°, in steps of 10°
 Supply voltage: 10 ÷ 30 Vdc
 IP code: **IP 65**

*: TOLERANCE BETWEEN DOWEL HOLES ± 0,02, BETWEEN SCREW HOLES ± 0,1

Subject to technical modifications without notice

UAGP605ZK__WS0

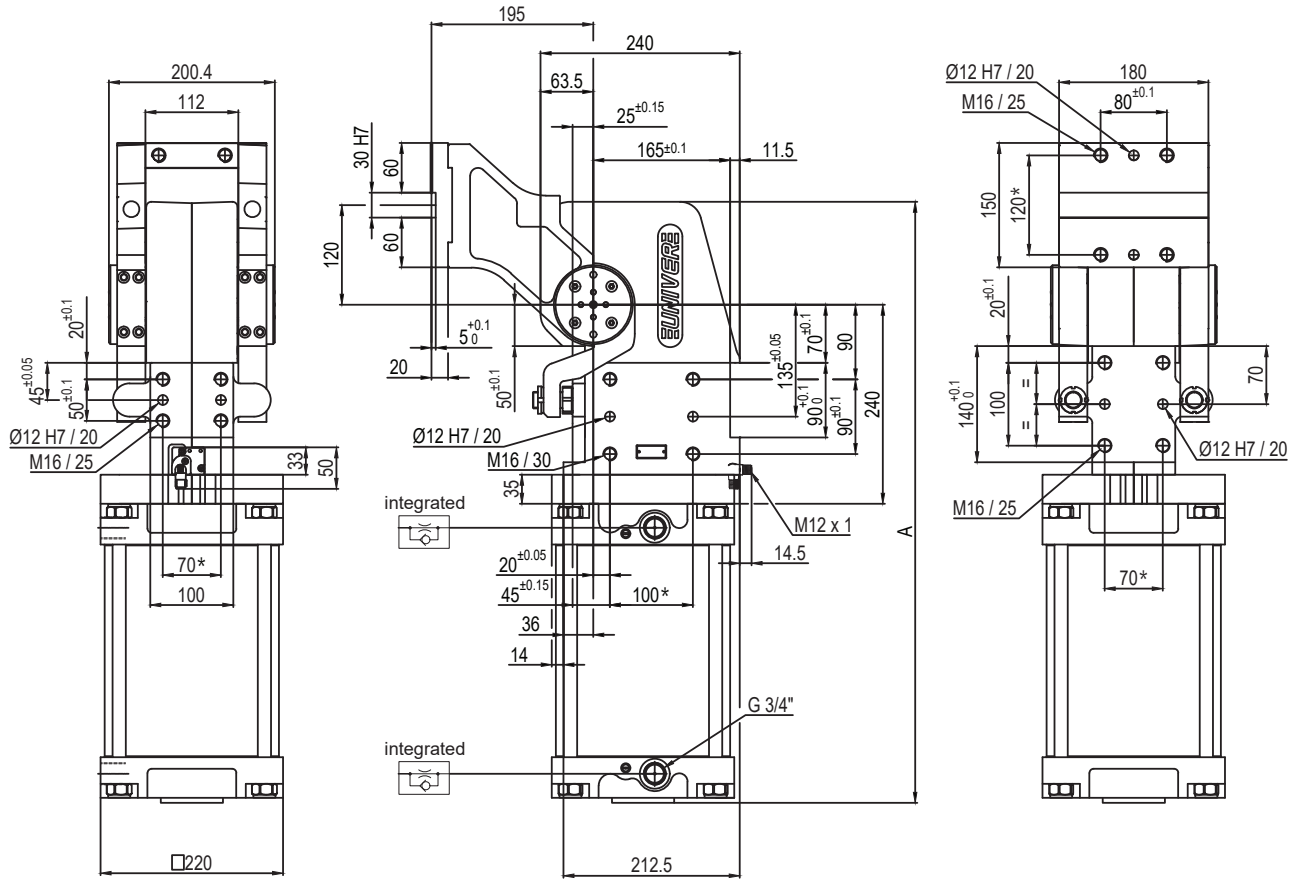

Pivot rotation in degrees	A
45°	632.5
60°	648.5
90°	685.5
120°	724.5

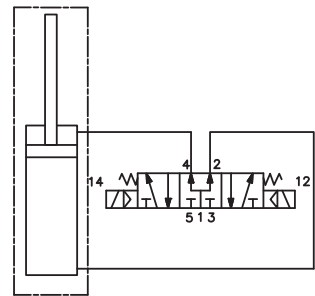
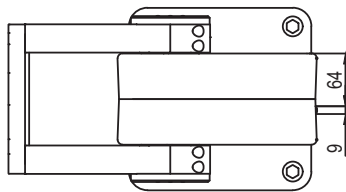

Size	Holding moment	Max. torque at the rotary table 0,55 MPa	Weight
605	8000 Nm	600 Nm	54 Kg

Min./Max. operating pressure: **0,4 / 0,6 MPa**
 Operating temperature: **5° ÷ 45° C**
 Predetermine pivot rotation in degrees: **45° - 60° - 90° - 120°**
 Rotary table position: **Vertical, mirror of V**
 Electronic sensor with M12 swivel connector, from 0° or 90°, in steps of 10°
 Supply voltage: 10 ÷ 30 Vdc
 IP code: **IP 65**

*: TOLERANCE BETWEEN DOWEL HOLES ± 0,02, BETWEEN SCREW HOLES ± 0,1

Subject to technical modifications without notice